



COLD SHRINKABLE CABLE ACCESSORIES

MELEC cold shrink technology is engineered for easy installation and long-term performance of the application.

Our cold shrink accessories offer a reliable sealing solution for low and medium voltage applications. This solution is ideal for confined work areas and areas where heat tools are not allowed or accessible.

Cold shrinkable body is a one-piece design with an outer layer of highly track resistant silicone rubber and integrated geometric stress cone. All components are pre-expanded on a spiral holdout providing a suitable diameter to allow easy locating over cables. Once correctly located, they shrink by simply pulling out the spiral holdout and fit the cable tightly which helps minimize installation time in enclosed or contaminated environments.

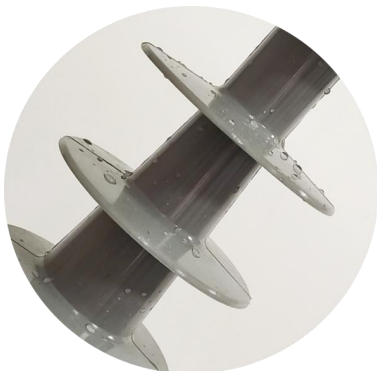

Key Features

- Quick and easy installation without heat source or tools
- Good electrical insulation and sealing properties
- Superior hydrophobicity property
- Excellent resilience
- High track resistant
- Outstanding weathering, UV and Ozone Resistance
- Efficient electrical stress control using integrated conductive geometrical stress cones.

Testing

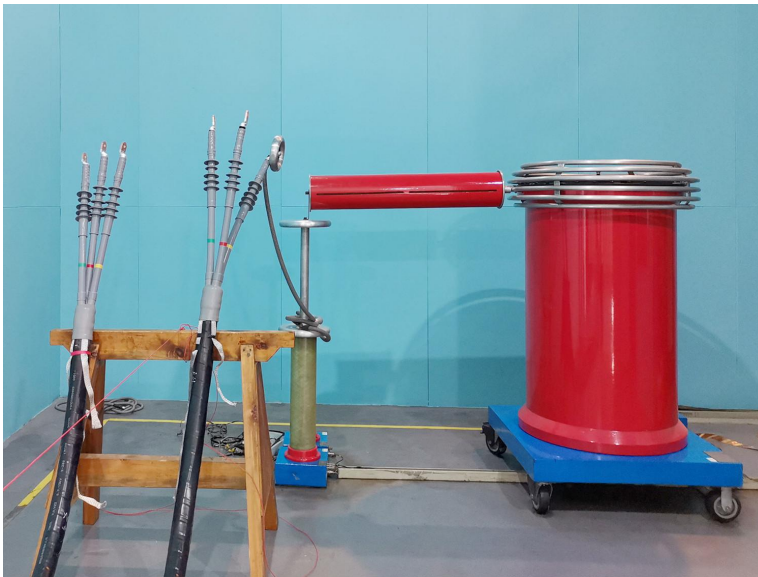

Partial discharge test



Impulse voltage test



Salt fog test

Content

1kV Cold Shrinkable Accessories

Introduction..... 5

Terminations

[For unarmoured cables](#)..... 6

[For armoured cables](#)..... 7

Straight Joints

[For unarmoured cables](#)..... 8

[For armoured cables](#)..... 9

15kV Cold Shrinkable Accessories

Introduction..... 10

Terminations

[For unarmoured cables](#)..... 11

[For armoured cables](#)..... 15

Straight Joints

[For unarmoured cables](#)..... 19

[For armoured cables](#)..... 21

1kV Cold Shrinkable Cable Accessories

MELEC 1kV cold shrinkable cable accessories are suitable for 0.6/1.0(1.2) kV, insulated with PVC, XLPE and PE polymeric cables. These accessories can be equipped with crimping lugs and connectors.

Standard

JB/T 7829:2006; JB/T 7830:2006

Performance

Test	Requirements
AC voltage withstand	8kV, 5 min. No failure. 7.2kV, 1 min. No failure.
Heating cycle (in air)	For terminations: 50 cycles at 4.5kV, no failure; For joints: 30 cycles at 4.5kV, no failure.
Heating cycle (in water)	For terminations: 10cycles, no voltage; For joints: 30cycles at 4.5kV. No failure.
AC voltage withstand (only for joints)	4.5kV, 15 min. No failure.
Thermal short-circuit (conductor)	Two short-circuits to raise conductor to θ_{sc} of the cable. No visible deterioration
Dynamic short-circuit	One short-circuit at I_d . No visible deterioration
AC voltage withstand (only for terminations)	4.5kV, 15 min. No failure.
Visual inspection	After all tests, no crack on any component.

* θ_{sc} is maximum permissible short-circuit temperature of the cable conductor;

I_d is short-circuit current (initial peak value) in the conductor.

1kV Cold Shrinkable Termination Accessories

Application

MLD is suitable for multicore, unarmoured cables.

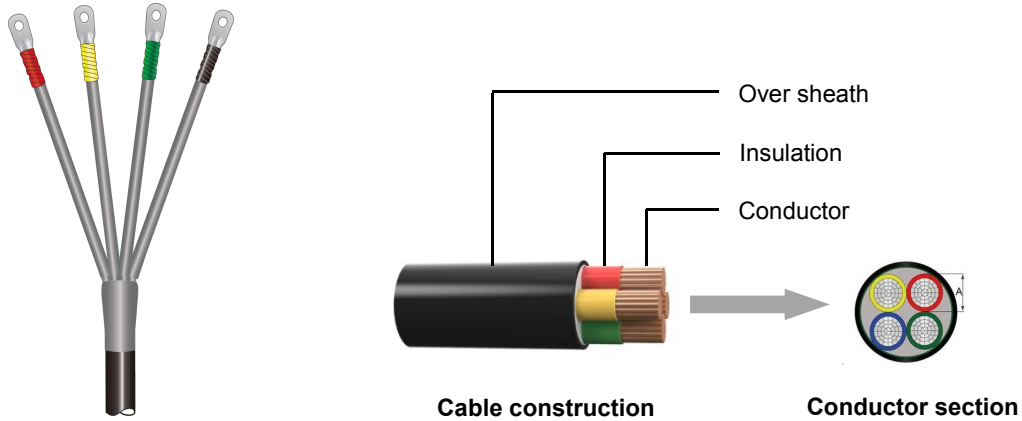

Cores	Type	Cross-section (mm ²)	Min. Dia over Insulation A (mm)	Max. Dia over Lugs (mm)	Recommended Cable Lugs
 4-core	MLD-01-4-A/00	25-50	7.0	16.0	AUS AU CALB-N
	MLD-01-4-B/00	70-120	11.0	23.0	
	MLD-01-4-C/00	150-240	16.0	30.0	
	MLD-01-4-D/00	300-400	22.7	38.0	

Standard Package List

Items	
CABLE LUG	EMERY CLOTH
COLD SHRINKABLE INSULATION BREAKOUT	CLEANING KIT
COLD SHRINKABLE INSULATION TUBING	UNDERSHIRT CLOTH GLOVES
SILICONE RUBBER INSULATING TAPE	INSTALLATION INSTRUCTION
WATERPROOF SEALING MASTIC	PACKAGE LIST
PVC TAPE	

Note: Please consult MELEC sales for more details.

1kV Cold Shrinkable Termination Accessories

Application

MLD is suitable for multicore, steel tape armoured cables.

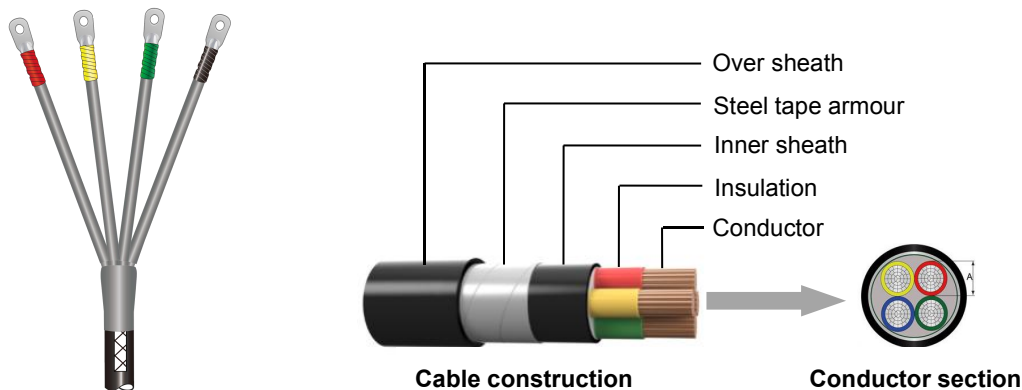

Cores	Type	Cross-section (mm ²)	Min. Dia over Insulation A (mm)	Max. Dia over Lugs (mm)	Recommended Cable Lugs
 4-core	MLD-01-4-A/10	25-50	7.0	16.0	AUS AU CALB-N
	MLD-01-4-B/10	70-120	11.0	23.0	
	MLD-01-4-C/10	150-240	16.0	30.0	
	MLD-01-4-D/10	300-400	22.7	38.0	

Standard Package List

Items	
CABLE LUG	PVC TAPE
COLD SHRINKABLE INSULATION BREAKOUT	EMERY CLOTH
COLD SHRINKABLE INSULATION TUBING	CLEANING KIT
COPPER BRAID	UNDERSHIRT CLOTH GLOVES
CONSTANT FORCE SPRING	INSTALLATION INSTRUCTION
SILICONE RUBBER INSULATING TAPE	PACKAGE LIST
WATERPROOF SEALING MASTIC	

Note: Please consult MELEC sales for more details.

1kV Cold Shrinkable Straight Joint Accessories

Application

MLJ is suitable for multicore, unarmoured cables.

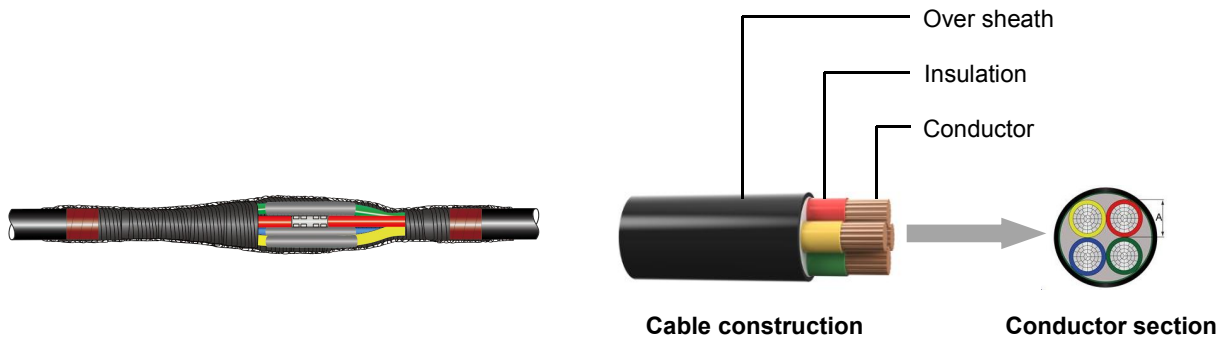

Cores	Type	Cross-section (mm ²)	Min. Dia over Insulation A (mm)	Max. Dia over Connectors (mm)	Max. Length of Connector (mm)	Recommended Connectors
 4-core	MLJ-01-4-A/00	25-50	7.0	16.0	80.0	GTD GLI
	MLJ-01-4-B/00	70-120	11.0	23.0	100.0	
	MLJ-01-4-C/00	150-240	16.0	30.0	120.0	
	MLJ-01-4-D/00	300-400	22.7	38.0	140.0	

Standard Package List

Items	
CABLE CONNECTOR	LATEX GLOVES
COLD SHRINKABLE INSULATION TUBING	EMERY CLOTH
WATERPROOF INSULATING MASTIC TAPE	CLEANING KIT
ARMOR-WRAP	UNDERSHIRT CLOTH GLOVES
WATERPROOF SEALING MASTIC	INSTALLATION INSTRUCTION
PVC TAPE	PACKAGE LIST

Note: Please consult MELEC sales for more details.

1kV Cold Shrinkable Straight Joint Accessories

Application

MLJ is suitable for multicore, steel tape armoured cables.

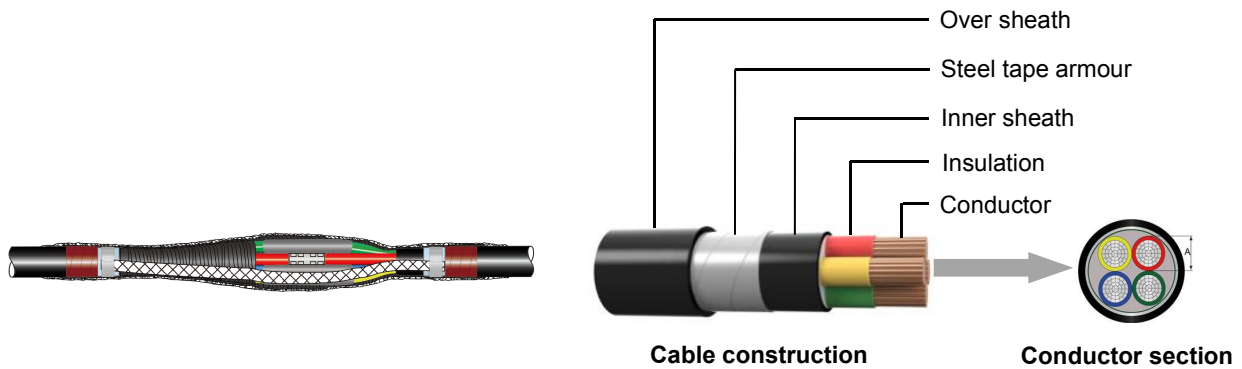

Cores	Type	Cross-section (mm ²)	Min. Dia over Insulation A (mm)	Max. Dia over Connectors (mm)	Max. Length of Connector (mm)	Recommended Connectors
 4-core	MLJ-01-4-A/10	25-50	7.0	16.0	80.0	GTD GLI
	MLJ-01-4-B/10	70-120	11.0	23.0	100.0	
	MLJ-01-4-C/10	150-240	16.0	30.0	120.0	
	MLJ-01-4-D/10	300-400	22.7	38.0	140.0	

Standard Package List

Items	
CABLE CONNECTOR	PVC TAPE
COLD SHRINKABLE INSULATION TUBING	LATEX GLOVES
WATERPROOF INSULATING MASTIC TAPE	EMERY CLOTH
ARMOR-WRAP	CLEANING KIT
COPPER BRAID	UNDERSHIRT CLOTH GLOVES
CONSTANT FORCE SPRING	INSTALLATION INSTRUCTION
WATERPROOF SEALING MASTIC	PACKAGE LIST

Note: Please consult MELEC sales for more details.

15kV Cold Shrinkable Cable Accessories

MELEC 15kV cold shrinkable cable accessories are suitable for 8.7/15(17.5) kV, insulated with PVC, XLPE and PE polymeric cables. These accessories can be equipped with crimping lugs and connectors.

Standard

IEC 60502-4

Performance

Test	Requirements
AC and DC voltage	AC for 5min at 4.5 U_0 and DC for 15min at 4 U_0
AC (wet) (only for outdoor terminations)	1 min at 4 U_0
Partial discharge	10pC max. at 1.73 U_0
Impulse at θ_t	10 impulses of each polarity
Heating cycles in air	60 cycles at θ_t and 2.5 U_0 ;
Immersion test (only for outdoor terminations)	10 cycles at θ_t
Partial discharge at θ_t and ambient temperature	10pC max. at 1.73 U_0
Thermal short-circuit (screen)	Two short-circuits at I_{sc} of the cable screen. No visible deterioration.
Thermal short-circuit (conductor)	Two short-circuits to raise conductor to θ_{sc} of the cable. No visible deterioration.
Dynamic short-circuit	One short-circuit at I_d . No visible deterioration
Impulse	10 impulses of each polarity
AC voltage	15 min at 2.5 U_0
Humidity (only for indoor terminations)	300h at 1.25 U_0
Salt fog (only for outdoor terminations)	1000h at 1.25 U_0

* θ_t is the maximum cable conductor temperature in normal operation +5K to +10K;

θ_{sc} is maximum permissible short-circuit temperature of the cable conductor;

I_{sc} is short-circuit current (r.m.s. value) in the metallic screen;

I_d is short-circuit current (initial peak value) in the conductor.

15kV Cold Shrinkable Termination Accessories

Application

MLN is an indoor kit suitable for 3-core, unarmoured cables with copper tape screen.

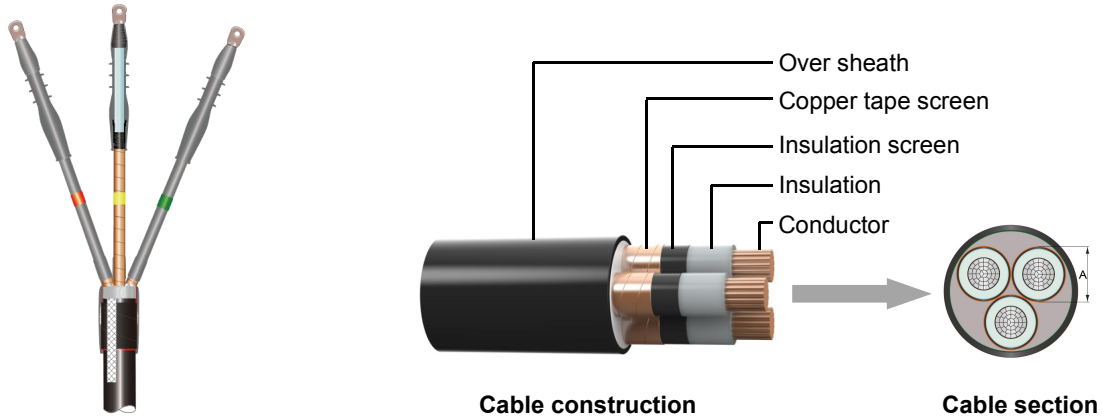

Cores	Type	Cross-section (mm ²)	Dia over Insulation A (mm)	Max. Dia over Lugs (mm)	Recommended Cable Lugs
 3-core	MLN-15-3-25-50/01	25-50	18.5-20.5	16.0	AUS AU CALB-N
	MLN-15-3-70-120/01	70-120	22.1-25.1	23.0	
	MLN-15-3-150-240/01	150-240	26.7-30.5	30.0	
	MLN-15-3-300-400/01	300-400	32.7-35.6	38.0	

Standard Package List

Items	
CABLE LUG	CONSTANT FORCE SPRING
COLD SHRINKABLE INSULATION BREAKOUT	PVC TAPE
COLD SHRINKABLE INDOOR TERMINATION BODY	SCALEPLATE
COLD SHRINKABLE INSULATION TUBING	EMERY CLOTH
COLD SHRINKABLE SEALING TUBING	CLEANING KIT
SEMI-CONDUCTIVE TAPE	CLEANING CLOTH
INSULATION SELF-ADHESIVE TAPE	PE GLOVES
WATERPROOF INSULATION MASTIC TAPE	UNDERSHIRT CLOTH GLOVES
SILICON GREASE	INSTALLATION INSTRUCTION
WATERPROOFING SEALING MASTIC	PACKAGE LIST
COPPER BRAID (FOR SCREEN)	

Note: Please consult MELEC sales for more details.

15kV Cold Shrinkable Termination Accessories

Application

MLW is an outdoor kit suitable for 3-core, unarmoured cables with copper tape screen.

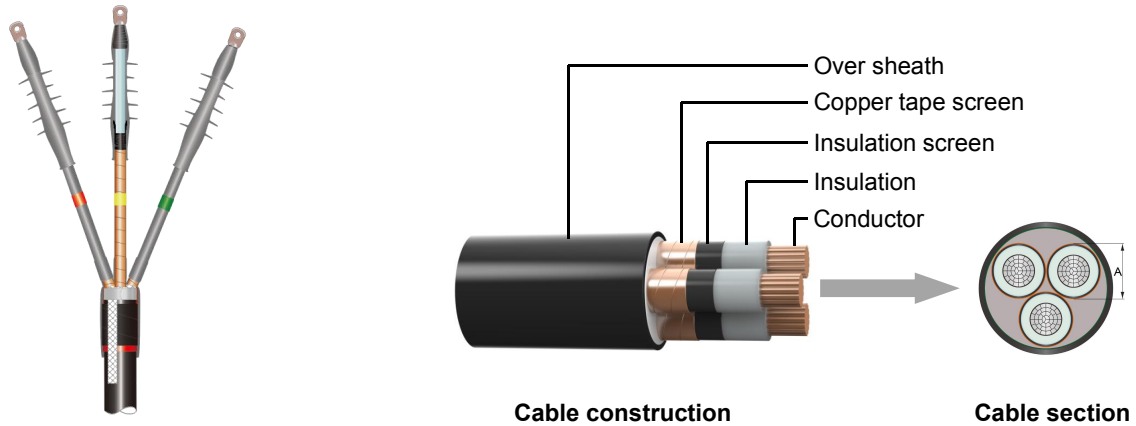

Cores	Type	Cross-section (mm ²)	Dia over Insulation A (mm)	Max. Dia over Lugs (mm)	Recommended Cable Lugs
 3-core	MLW-15-3-25-50/01	25-50	18.5-20.5	16.0	AUS AU CALB-N
	MLW-15-3-70-120/01	70-120	22.1-25.1	23.0	
	MLW-15-3-150-240/01	150-240	26.7-30.5	30.0	
	MLW-15-3-300-400/01	300-400	32.7-35.6	38.0	

Standard Package List

Items	
CABLE LUG	CONSTANT FORCE SPRING
COLD SHRINKABLE INSULATION BREAKOUT	PVC TAPE
COLD SHRINKABLE OUTDOOR TERMINATION BODY	SCALEPLATE
COLD SHRINKABLE INSULATION TUBING	EMERY CLOTH
COLD SHRINKABLE SEALING TUBING	CLEANING KIT
SEMI-CONDUCTIVE TAPE	CLEANING CLOTH
INSULATION SELF-ADHESIVE TAPE	PE GLOVES
WATERPROOF INSULATION MASTIC TAPE	UNDERSHIRT CLOTH GLOVES
SILICON GREASE	INSTALLATION INSTRUCTION
WATERPROOFING SEALING MASTIC	PACKAGE LIST
COPPER BRAID (FOR SCREEN)	

Note: Please consult MELEC sales for more details.

15kV Cold Shrinkable Termination Accessories

Application

MLN is an indoor kit suitable for single core, unarmoured cables with copper tape screen.

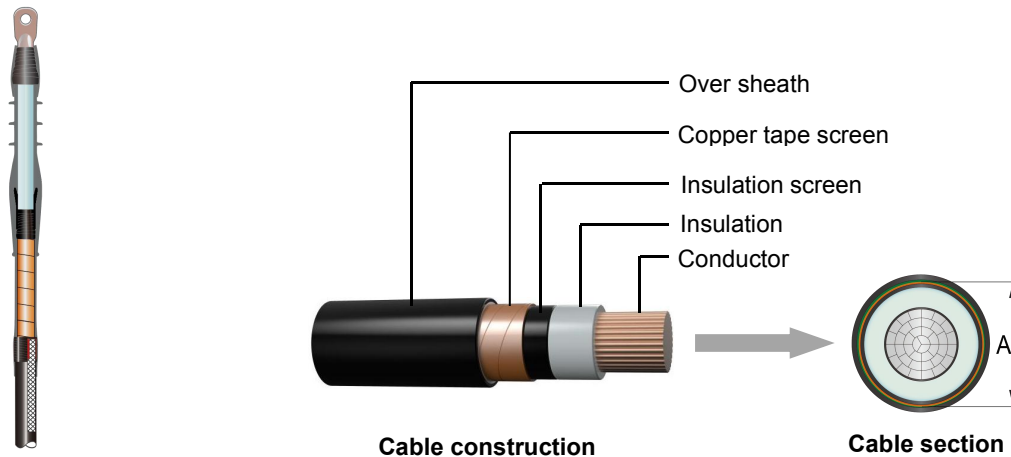

Cores	Type	Cross-section (mm ²)	Dia over Insulation A (mm)	Max. Dia over Lugs (mm)	Recommended Cable Lugs
 1-core	MLN-15-1-25-50/01	25-50	18.5-20.5	16.0	AUS AU CALB-N
	MLN-15-1-70-120/01	70-120	22.1-25.1	23.0	
	MLN-15-1-150-240/01	150-240	26.7-30.5	30.0	
	MLN-15-1-300-400/01	300-400	32.7-35.6	38.0	
	MLN-15-1-500-630/01	500-630	38.8-43.0	54.0	

Standard Package List

Items	
CABLE LUG	CONSTANT FORCE SPRING
COLD SHRINKABLE INDOOR TERMINATION BODY	PVC TAPE
COLD SHRINKABLE INSULATION TUBING	SCALEPLATE
COLD SHRINKABLE SEALING TUBING	EMERY CLOTH
SEMI-CONDUCTIVE TAPE	CLEANING KIT
INSULATION SELF-ADHESIVE TAPE	CLEANING CLOTH
WATERPROOF INSULATION MASTIC TAPE	PE GLOVES
SILICON GREASE	UNDERSHIRT CLOTH GLOVES
WATERPROOFING SEALING MASTIC	INSTALLATION INSTRUCTION
COPPER BRAID (FOR SCREEN)	PACKAGE LIST

Note: Please consult MELEC sales for more details.

15kV Cold Shrinkable Termination Accessories

Application

MLW is an outdoor kit suitable for single core, unarmoured cables with copper tape screen.

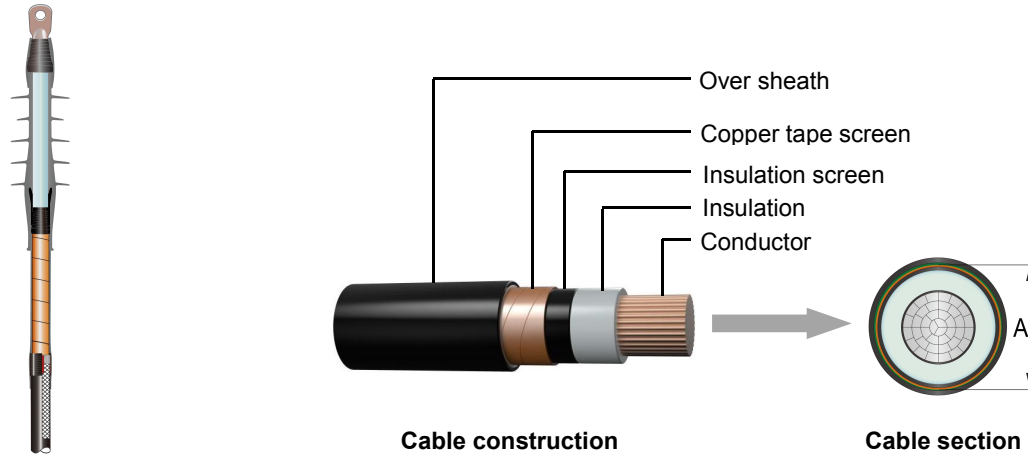

Cores	Type	Cross-section (mm ²)	Dia over Insulation A (mm)	Max. Dia over Lugs (mm)	Recommended Cable Lugs
 1-core	MLW-15-1-25-50/01	25-50	18.5-20.5	16.0	AUS AU CALB-N
	MLW-15-1-70-120/01	70-120	22.1-25.1	23.0	
	MLW-15-1-150-240/01	150-240	26.7-30.5	30.0	
	MLW-15-1-300-400/01	300-400	32.7-35.6	38.0	
	MLW-15-1-500-630/01	500-630	38.8-43.0	54.0	

Standard Package List

Items	
CABLE LUG	CONSTANT FORCE SPRING
COLD SHRINKABLE OUTDOOR TERMINATION BODY	PVC TAPE
COLD SHRINKABLE INSULATION TUBING	SCALEPLATE
COLD SHRINKABLE SEALING TUBING	EMERY CLOTH
SEMI-CONDUCTIVE TAPE	CLEANING KIT
INSULATION SELF-ADHESIVE TAPE	CLEANING CLOTH
WATERPROOF INSULATION MASTIC TAPE	PE GLOVES
SILICON GREASE	UNDERSHIRT CLOTH GLOVES
WATERPROOFING SEALING MASTIC	INSTALLATION INSTRUCTION
COPPER BRAID (FOR SCREEN)	PACKAGE LIST

Note: Please consult MELEC sales for more details.

15kV Cold Shrinkable Termination Accessories

Application

MLN is an indoor kit suitable for 3-core, steel tape armoured cables with copper tape screen.

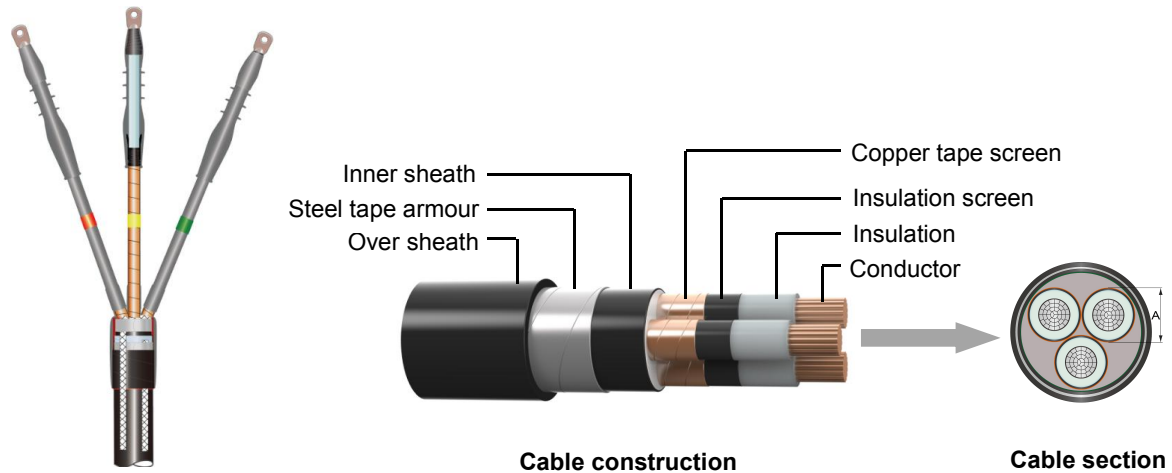

Cores	Type	Cross-section (mm ²)	Dia over Insulation A (mm)	Max. Dia over Lugs (mm)	Recommended Cable Lugs
 3-core	MLN-15-3-25-50/11	25-50	18.5-20.5	16.0	AUS AU CALB-N
	MLN-15-3-70-120/11	70-120	22.1-25.1	23.0	
	MLN-15-3-150-240/11	150-240	26.7-30.5	30.0	
	MLN-15-3-300-400/11	300-400	32.7-35.6	38.0	

Standard Package List

Items	
CABLE LUG	COPPER BRAID (FOR ARMOUR)
COLD SHRINKABLE INSULATION BREAKOUT	CONSTANT FORCE SPRING
COLD SHRINKABLE INDOOR TERMINATION BODY	PVC TAPE
COLD SHRINKABLE INSULATION TUBING	SCALEPLATE
COLD SHRINKABLE SEALING TUBING	EMERY CLOTH
SEMI-CONDUCTIVE TAPE	CLEANING KIT
INSULATION SELF-ADHESIVE TAPE	CLEANING CLOTH
WATERPROOF INSULATION MASTIC TAPE	PE GLOVES
SILICON GREASE	UNDERSHIRT CLOTH GLOVES
WATERPROOFING SEALING MASTIC	INSTALLATION INSTRUCTION
COPPER BRAID (FOR SCREEN)	PACKAGE LIST

Note: Please consult MELEC sales for more details.

15kV Cold Shrinkable Termination Accessories

Application

MLW is an outdoor kit suitable for 3-core, steel tape armoured cables with copper tape screen.

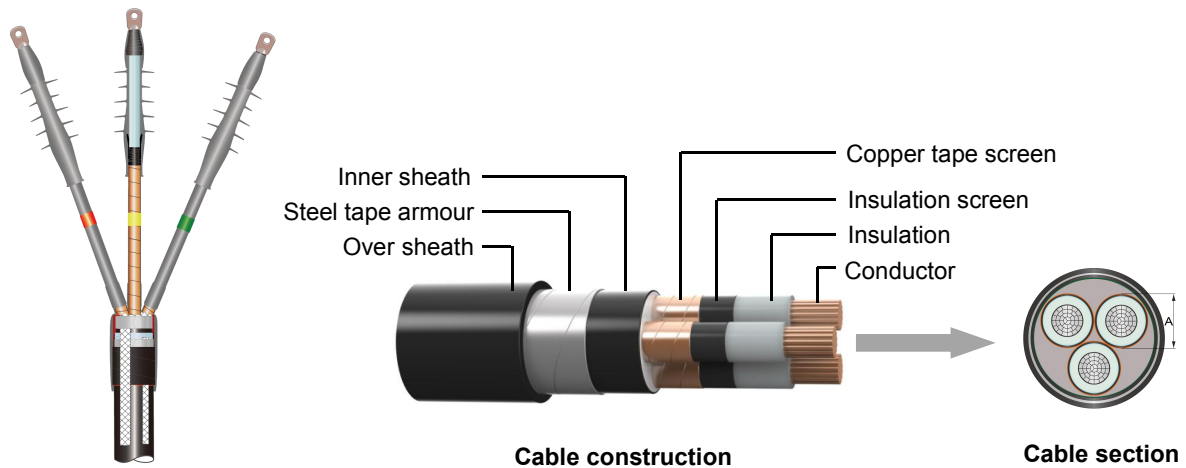

Cores	Type	Cross-section (mm ²)	Dia over Insulation A (mm)	Max. Dia over Lugs (mm)	Recommended Cable Lugs
 3-core	MLW-15-3-25-50/11	25-50	18.5-20.5	16.0	AUS AU CALB-N
	MLW-15-3-70-120/11	70-120	22.1-25.1	23.0	
	MLW-15-3-150-240/11	150-240	26.7-30.5	30.0	
	MLW-15-3-300-400/11	300-400	32.7-35.6	38.0	

Standard Package List

Items	
CABLE LUG	COPPER BRAID (FOR ARMOUR)
COLD SHRINKABLE INSULATION BREAKOUT	CONSTANT FORCE SPRING
COLD SHRINKABLE OUTDOOR TERMINATION BODY	PVC TAPE
COLD SHRINKABLE INSULATION TUBING	SCALEPLATE
COLD SHRINKABLE SEALING TUBING	EMERY CLOTH
SEMI-CONDUCTIVE TAPE	CLEANING KIT
INSULATION SELF-ADHESIVE TAPE	CLEANING CLOTH
WATERPROOF INSULATION MASTIC TAPE	PE GLOVES
SILICON GREASE	UNDERSHIRT CLOTH GLOVES
WATERPROOFING SEALING MASTIC	INSTALLATION INSTRUCTION
COPPER BRAID (FOR SCREEN)	PACKAGE LIST

Note: Please consult MELEC sales for more details.

15kV Cold Shrinkable Termination Accessories

Application

MLN is an indoor kit suitable for single core, steel tape armoured cables with copper tape screen.

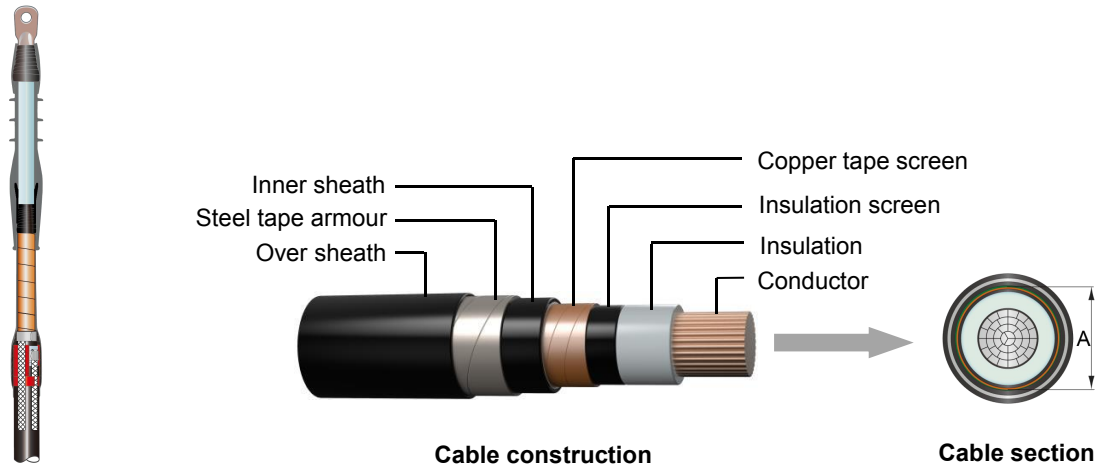

Cores	Type	Cross-section (mm ²)	Dia over Insulation A (mm)	Max. Dia over Lugs (mm)	Recommended Cable Lugs
 1-core	MLN-15-1-25-50/11	25-50	18.5-20.5	16.0	AUS AU CALB-N
	MLN-15-1-70-120/11	70-120	22.1-25.1	23.0	
	MLN-15-1-150-240/11	150-240	26.7-30.5	30.0	
	MLN-15-1-300-400/11	300-400	32.7-35.6	38.0	
	MLN-15-1-500-630/11	500-630	38.8-43.0	54.0	

Standard Package List

Items	
CABLE LUG	CONSTANT FORCE SPRING
COLD SHRINKABLE INDOOR TERMINATION BODY	PVC TAPE
COLD SHRINKABLE INSULATION TUBING	SCALEPLATE
COLD SHRINKABLE SEALING TUBING	EMERY CLOTH
SEMI-CONDUCTIVE TAPE	CLEANING KIT
INSULATION SELF-ADHESIVE TAPE	CLEANING CLOTH
WATERPROOF INSULATION MASTIC TAPE	PE GLOVES
SILICON GREASE	UNDERSHIRT CLOTH GLOVES
WATERPROOFING SEALING MASTIC	INSTALLATION INSTRUCTION
COPPER BRAID (FOR SCREEN)	PACKAGE LIST
COPPER BRAID (FOR ARMOUR)	

Note: Please consult MELEC sales for more details.

15kV Cold Shrinkable Termination Accessories

Application

MLW is an outdoor kit suitable for single core, steel tape armoured cables with copper tape screen.

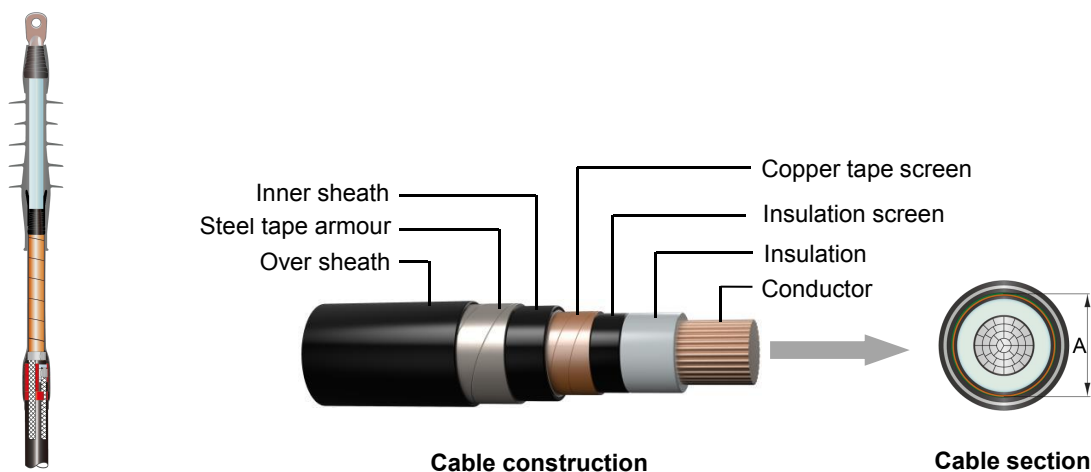

Cores	Type	Cross-section (mm ²)	Dia over Insulation A (mm)	Max. Dia over Lugs (mm)	Recommended Cable Lugs
 1-core	MLW-15-1-25-50/11	25-50	18.5-20.5	16.0	AUS AU CALB-N
	MLW-15-1-70-120/11	70-120	22.1-25.1	23.0	
	MLW-15-1-150-240/11	150-240	26.7-30.5	30.0	
	MLW-15-1-300-400/11	300-400	32.7-35.6	38.0	
	MLW-15-1-500-630/11	500-630	38.8-43.0	54.0	

Standard Package List

Items	
CABLE LUG	CONSTANT FORCE SPRING
COLD SHRINKABLE OUTDOOR TERMINATION BODY	PVC TAPE
COLD SHRINKABLE INSULATION TUBING	SCALEPLATE
COLD SHRINKABLE SEALING TUBING	EMERY CLOTH
SEMI-CONDUCTIVE TAPE	CLEANING KIT
INSULATION SELF-ADHESIVE TAPE	CLEANING CLOTH
WATERPROOF INSULATION MASTIC TAPE	PE GLOVES
SILICON GREASE	UNDERSHIRT CLOTH GLOVES
WATERPROOFING SEALING MASTIC	INSTALLATION INSTRUCTION
COPPER BRAID (FOR SCREEN)	PACKAGE LIST
COPPER BRAID (FOR ARMOUR)	

Note: Please consult MELEC sales for more details.

15kV Cold Shrinkable Straight Joint Accessories

Application

MLJ is suitable for 3-core, unarmoured cables with copper tape screen.

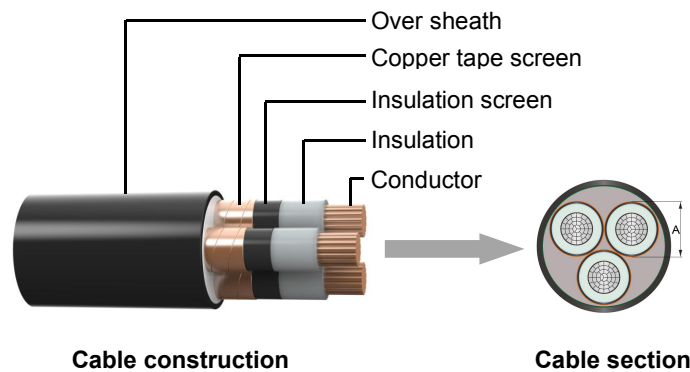

Cores	Type	Cross-section (mm ²)	Dia over Insulation A (mm)	Max. Dia over Connectors (mm)	Max. Length of Connector (mm)	Recommended Connectors
 3-core	MLJ-15-3-25-50/01	25-50	18.5-20.5	16.0	80.0	GTD GLI
	MLJ-15-3-70-120/01	70-120	22.1-25.1	23.0	100.0	
	MLJ-15-3-150-240/01	150-240	26.7-30.5	30.0	120.0	
	MLJ-15-3-300-400/01	300-400	32.7-35.6	38.0	140.0	

Standard Package List

Items	
CABLE CONNECTOR	PVC TAPE
COLD SHRINKABLE STRAIGHT JOINT BODY	WATERPROOF SEALING MASTIC
SEMI-CONDUCTIVE TAPE	EMERY CLOTH
SILICONE GREASE	CLEANING KIT
COPPER BRAID (FOR SCREEN)	CLEANING CLOTH
TINNED SHIELDING COPPER NET	PE GLOVES
CONSTANT FORCE SPRING	UNDERSHIRT CLOTH GLOVES
WATERPROOF INSULATION MASTIC TAPE	INSTALLATION INSTRUCTION
ARMOR-WRAP	PACKAGE LIST
LATEX GLOVES	

Note: Please consult MELEC sales for more details.

15kV Cold Shrinkable Straight Joint Accessories

Application

MLJ is suitable for single core, unarmoured cables with copper tape screen.

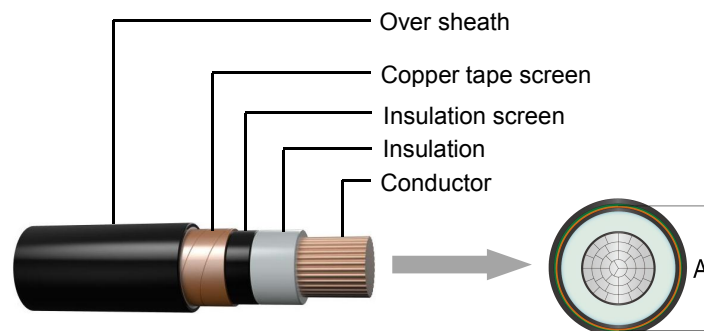
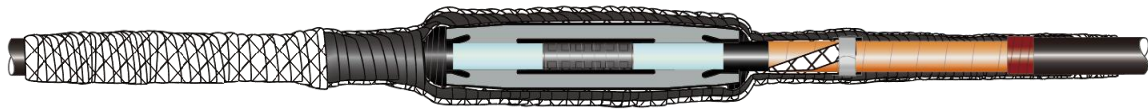

Cable construction

Cable section

Cores	Type	Cross-section (mm ²)	Dia over Insulation A (mm)	Max. Dia over Connectors (mm)	Max. Length of Connector (mm)	Recommended Connectors
 1-core	MLJ-15-1-25-50/01	25-50	18.5-20.5	16.0	80.0	GTD GLI
	MLJ-15-1-70-120/01	70-120	22.1-25.1	23.0	100.0	
	MLJ-15-1-150-240/01	150-240	26.7-30.5	30.0	120.0	
	MLJ-15-1-300-400/01	300-400	32.7-35.6	38.0	140.0	
	MLJ-15-1-500-630/01	500-630	38.8-43.0	54.0	170.0	

Standard Package List

Items	
CABLE CONNECTOR	PVC TAPE
COLD SHRINKABLE STRAIGHT JOINT BODY	WATERPROOF SEALING MASTIC
SEMI-CONDUCTIVE TAPE	EMERY CLOTH
SILICONE GREASE	CLEANING KIT
COPPER BRAID (FOR SCREEN)	CLEANING CLOTH
TINNED SHIELDING COPPER NET	PE GLOVES
CONSTANT FORCE SPRING	UNDERSHIRT CLOTH GLOVES
WATERPROOF INSULATION MASTIC TAPE	INSTALLATION INSTRUCTION
ARMOR-WRAP	PACKAGE LIST
LATEX GLOVES	

Note: Please consult MELEC sales for more details.

15kV Cold Shrinkable Straight Joint Accessories

Application

MLJ is suitable for 3-core, steel tape armoured cables with copper tape screen.

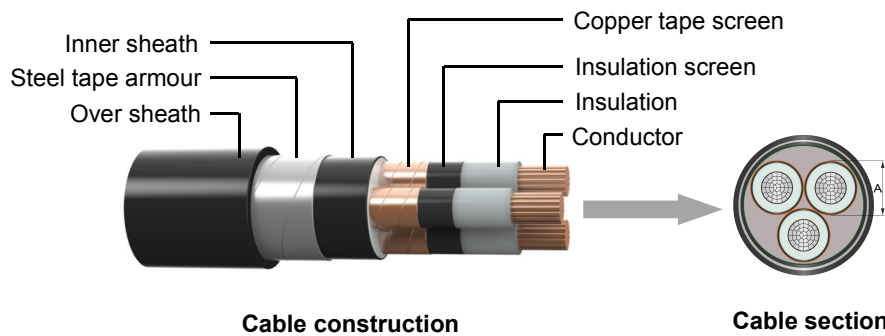

Cores	Type	Cross-section (mm ²)	Dia over Insulation A (mm)	Max. Dia over Connectors (mm)	Max. Length of Connector (mm)	Recommended Connectors
 3-core	MLJ-15-3-25-50/11	25-50	18.5-20.5	16.0	80.0	GTD GLI
	MLJ-15-3-70-120/11	70-120	22.1-25.1	23.0	100.0	
	MLJ-15-3-150-240/11	150-240	26.7-30.5	30.0	120.0	
	MLJ-15-3-300-400/11	300-400	32.7-35.6	38.0	140.0	

Standard Package List

Items	
CABLE CONNECTOR	PVC TAPE
COLD SHRINKABLE STRAIGHT JOINT BODY	COPPER BRAID (FOR ARMOUR)
SEMI-CONDUCTIVE TAPE	WATERPROOF SEALING MASTIC
SILICONE GREASE	EMERY CLOTH
COPPER BRAID (FOR SCREEN)	CLEANING KIT
TINNED SHIELDING COPPER NET	CLEANING CLOTH
CONSTANT FORCE SPRING	PE GLOVES
WATERPROOF INSULATION MASTIC TAPE	UNDERSHIRT CLOTH GLOVES
ARMOR-WRAP	INSTALLATION INSTRUCTION
LATEX GLOVES	PACKAGE LIST

Note: Please consult MELEC sales for more details.

15kV Cold Shrinkable Straight Joint Accessories

Application

MLJ is suitable for single core, steel tape armoured cables with copper tape screen.

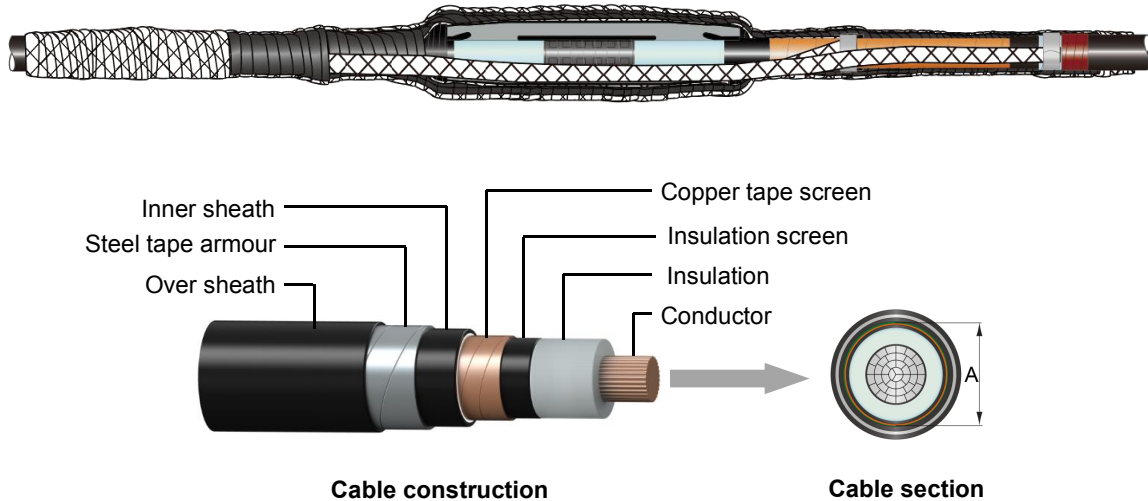

Cores	Type	Cross-section (mm ²)	Dia over Insulation A (mm)	Max. Dia over Connectors (mm)	Max. Length of Connector (mm)	Recommended Connectors
 1-core	MLJ-15-1-25-50/11	25-50	18.5-20.5	16.0	80.0	GTD GLI
	MLJ-15-1-70-120/11	70-120	22.1-25.1	23.0	100.0	
	MLJ-15-1-150-240/11	150-240	26.7-30.5	30.0	120.0	
	MLJ-15-1-300-400/11	300-400	32.7-35.6	38.0	140.0	
	MLJ-15-1-500-630/11	500-630	38.8-43.0	54.0	170.0	

Standard Package List

Items	
CABLE CONNECTOR	PVC TAPE
COLD SHRINKABLE STRAIGHT JOINT BODY	COPPER BRAID (FOR ARMOUR)
SEMI-CONDUCTIVE TAPE	WATERPROOF SEALING MASTIC
SILICONE GREASE	EMERY CLOTH
COPPER BRAID (FOR SCREEN)	CLEANING KIT
TINNED SHIELDING COPPER NET	CLEANING CLOTH
CONSTANT FORCE SPRING	PE GLOVES
WATERPROOF INSULATION MASTIC TAPE	UNDERSHIRT CLOTH GLOVES
ARMOR-WRAP	INSTALLATION INSTRUCTION
LATEX GLOVES	PACKAGE LIST

Note: Please consult MELEC sales for more details.